

 Banco da lavoro mobile 1,14 x 0,73 m

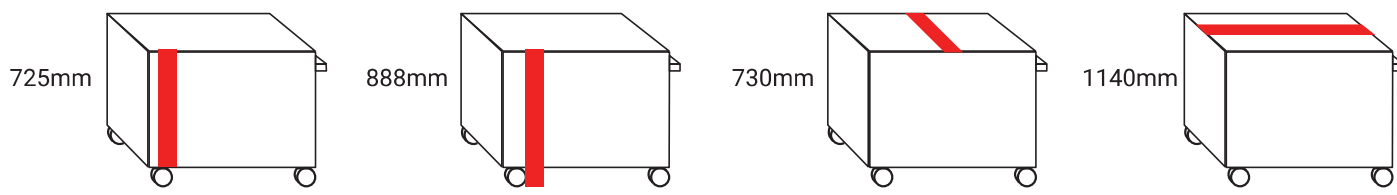

 **Caratteristiche:**

Pannello di legno
Spessore struttura dei cassetti: 0,8-1,2 mm
Spessore dei cassetti: 0,8 mm
Dimensioni dell'imballaggio: 1190x770x1036mm
Banco da lavoro mobile dimensioni generali:
Altezza: 725 mm

Altezza (con ruote): 888 mm
Larghezza: 730 mm
Lunghezza: 1140 mm

Dimensioni cassetti:
(6x) 570x410x83 mm
(2x) 570x410x112 mm
(2x) 570x410x228 mm
Dimensioni armadio:
600x190x600 mm

REF

8700



140kg

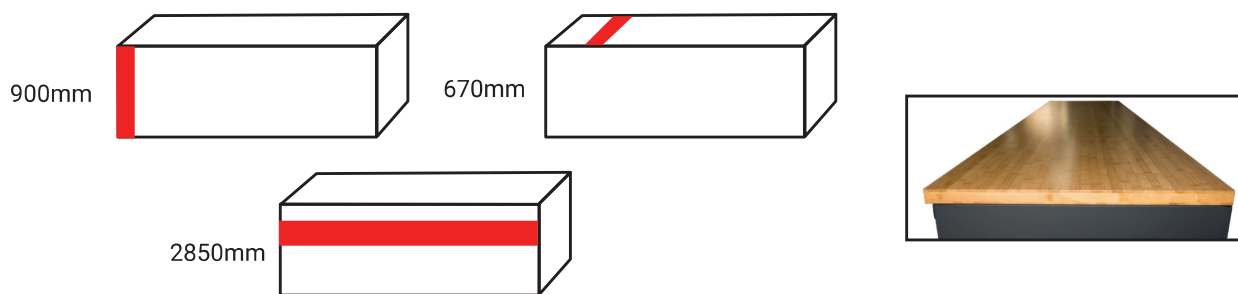

1x

Banco da lavoro con cassetti 2,85m

Caratteristiche:

Dimensioni del banco:
 Altezza 900 mm, larghezza 670 mm, lunghezza 2850 mm
 Dimensioni dei cassetti: (12x) 500x130x580 mm
 Armadio: 600x560x680 mm

Spessore del coperchio di bambù: 35 mm
 Spessore della struttura d'acciaio 0,9 mm,
 Cassetti d'acciaio: 0,7 mm
 Portata mas. (totale): 500 kg; 35 kg (cassetti); 45 kg (armadi)

REF

8670



206kg

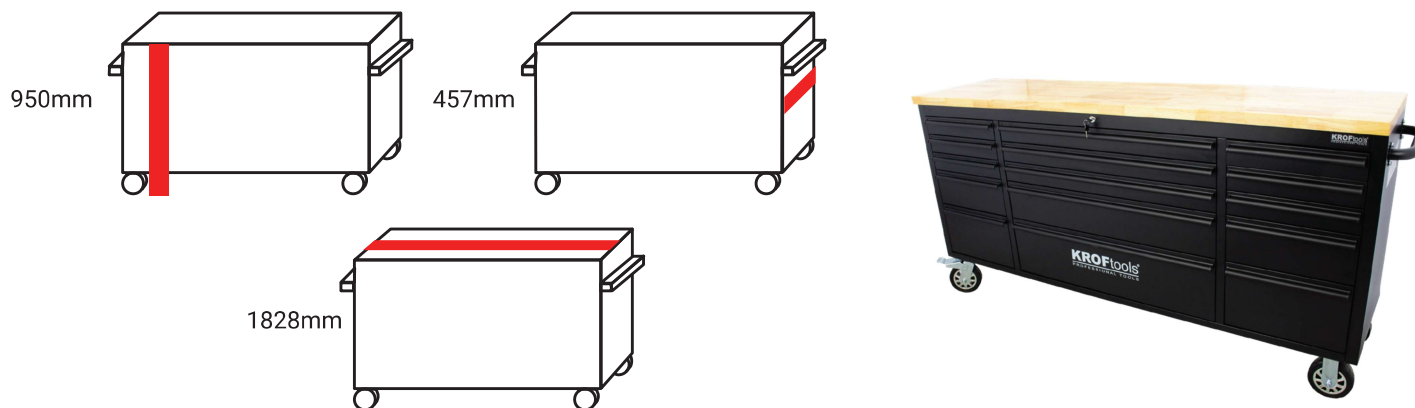

1x

 Armadio portautensili 14 cassetti

 **Caratteristiche:**

Misure:
 Altezza: 950 mm, Larghezza: 457 mm, Lunghezza: 1828 mm

Misure dei cassetti:
 Cassetti grandi - 850 mm x 380 mm
 Cassetti piccoli - 370 mm x 380 mm

Caratteristiche:
 Piano in legno 30 mm di spessore
 Cassetti con rivestimento
 2 x Maniglie laterali
 2 Ruote girevoli 150 mm con freno
 2x Ruote girevoli 150 mm

REF

8672



135kg



1x

 84" banco da lavoro mobile

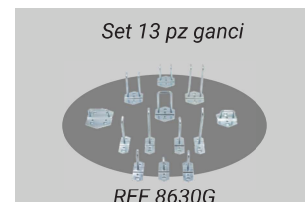
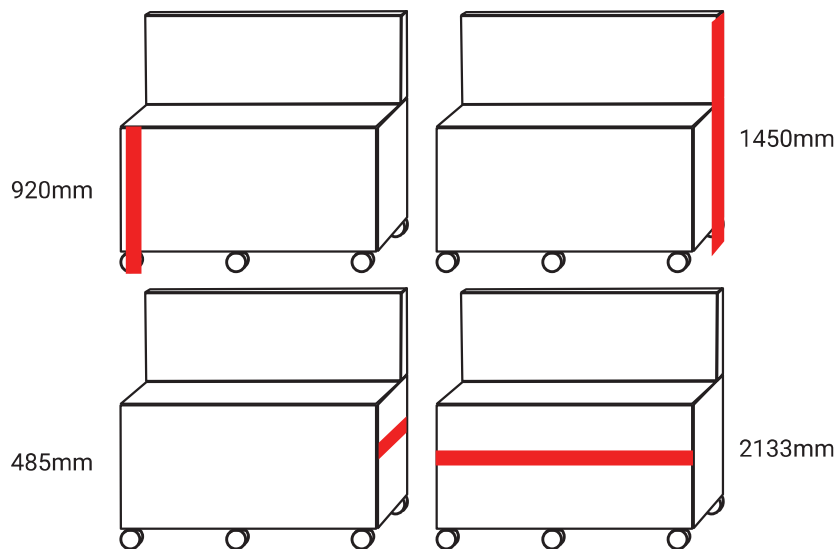

 **Caratteristiche:**

Dimensioni carrello:
 Altezza: 1450 mm (con pannello), larghezza: 485 mm,
 Lunghezza: 2133 mm
 Dimensioni cassetti:
 (3x) 950,2x398,2x65,7 mm, (1x) 950,2x398,2x144,7 mm
 (1x) 950,2x398,2x224,7 mm, (3x) 430,7x398,2x65,7 mm
 (1x) 430,7x398,2x144,7 mm, (1x) 430,7x398,2x224,7 mm

REF

8630



145kg

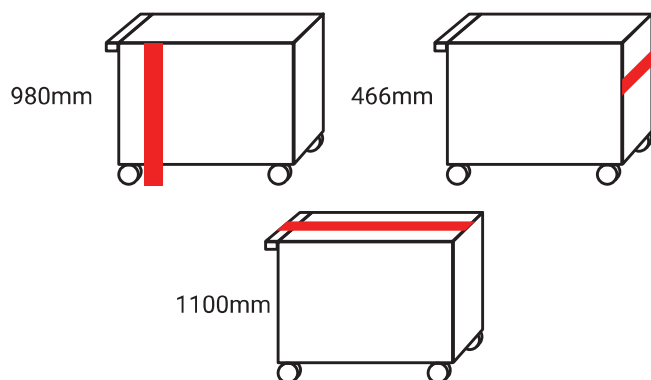

1x

 Armadio portautensili 14 cassetti

 **Caratteristiche:**

Dimensioni carrello:

Altezza 980 mm, larghezza 466 mm, lunghezza 1110 mm (con impugnatura)

Dimensioni cassetti:

Grande: (5x) 535x395x60 mm, (2x) 535x395x140 mm

Piccolo: (5x) 280x395x60 mm, (2x) 280x395x140 mm

REF

8660



90,2kg



1x

 Armadio portautensili vuoto 7 cassetti

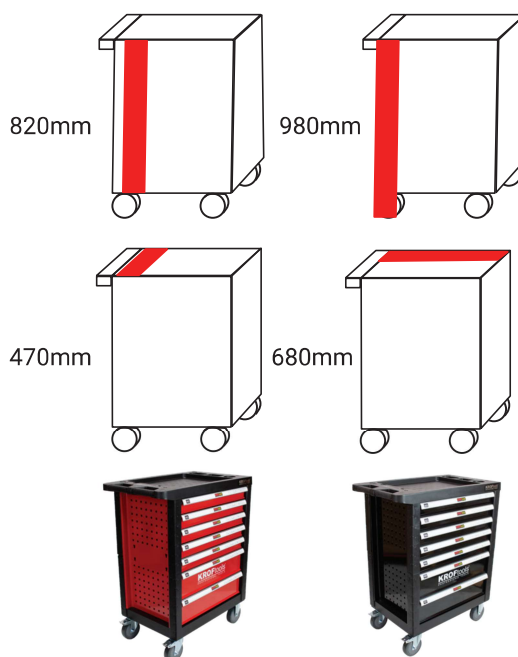

Possibilità di scelta del colore:

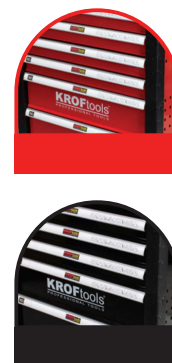

 Caratteristiche:

Dimensioni carrello:
Altezza (con ruote): 980 mm
Larghezza: 460 mm
Lunghezza: 680 mm

Dimensioni cassetti:
(5x) 60x400x530 mm. (2x) 140x400x530 mm

REF

8611



50kg



1x

 Carrello portautensili 3 livelli

910mm



410mm



760mm

 **Caratteristiche:**

Dimensioni: 760x410x910 mm
 Spessore livello 0,7 mm
 Materiale colonna 1,2 mm
 Carrello per garage od officina con portata di 50 kg per scaffale
 Rotelle 4x4"

REF



8590

16kg

1x

 Carrello portautensili 3 livelli con supporti

775mm



353mm



703mm

 **Caratteristiche:**

Dimensioni carrello:
 Altezza 775 mm (con ruote), larghezza 703 mm, lunghezza 353 mm
 Caratteristiche:
 Rotelle (4x) 3" (2x con freno)
 Portata 20 kg per scaffale

REF



8690

10,4kg

1x

Portaoggetti magnetico per guanti/panni



Caratteristiche:

Stand per contenitore guanti o carta monouso di dimensioni standard. Comprende quattro magneti che fissano il supporto. Capacità del magnete: 3,6 kg. Dimensioni generali: 143x95x253 mm

REF		
8632	958gr	24x

Secchio laterale per armadio portautensili

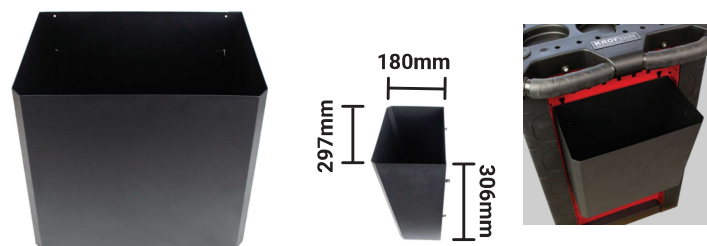

Dimensioni:

Altezza 306 mm, larghezza 180 mm, lunghezza 297 mm

REF		
8531	800gr	2x

Portaspray magnetico



Caratteristiche:

Portaspray per una bomboletta e due chiavi con impugnatura. Comprende tre magneti rivestiti per evitare di graffiare le superfici. Può essere collegato a una cassetta utensili o a qualsiasi superfici metallica. Costruzione robusta di acciaio

REF		
8633	416gr	12x

Supporto per spray e altro per l'armadio portautensili



Portachavi inglesi magnetico



Caratteristiche:

Portautensili magnetico per fino a 12 chiavi. Portata fino a 3,5 kg. Possibilità di fissaggio a parete. Realizzato in ABS per garantire la resistenza massima

REF		
8634	333gr	24x

 Ripostiglio laterale per armadio portautensili

 Dimensioni:

Altezza: 670 mm
 Larghezza: 50 mm
 Lunghezza: 297 mm

REF		
8530	5kg	1x

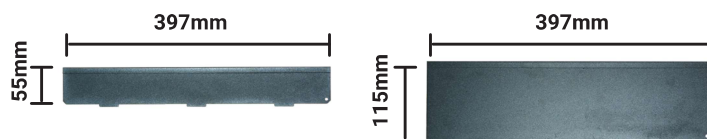
 Divisioni per armadio portautensili

 Dimensioni:



8581: Altezza 55 mm, lunghezza 397 mm
 8582: Altezza 115 mm, lunghezza 397 mm

REF		
8581	1kg	100x
8582	1kg	100x

 Gancio di supporto

 Dimensioni:

8535: Lunghezza 50 mm
 8536: Lunghezza 75 mm

REF		
8535	10gr	100x
8536	10gr	100x

Chiave a bussola da 1/4" 42 pezzi

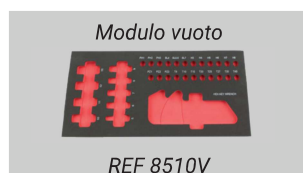
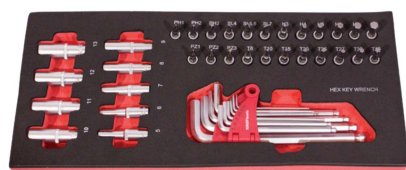

Composizione:

- (9x) Chiavi a bussola esagonali profonde 1/4": 5, 6, 7, 8, 9, 10, 11, 12, 13 mm
- (23x) Chiavi a bussola bit torx da 1/4": 8, T10, T15, T20, T25, T27, T30, T40; PH1, 2, 3; PZ1, 2, 3; Fenda 4, 5, 5, 7; H3, 4, 5, 6, 7, 8 mm
- (10x) Chiavi Umbrako da 1,5, 2, 2,5, 3, 4, 5, 5,5, 6, 8, 10 mm

REF			
8510	385x170mm	1,14kg	5x

Set di bussole da 3/8" 8-24 mm 20 pezzi



Composizione:

- (15x) Chiavi a bussola esagonali da 3/8" 8, 9, 10, 11, 12, 13, 14, 15, 16, 17, 18, 19, 21, 22, 24 mm
- (1x) Snodo da 3/8" 50 mm
- (1x) Barra scorrevole da 3/8" 160 mm
- (2x) Prolunghe da 3/8" 75 mm e 150 mm
- (1x) Cricchetto da 3/8"

REF			
8573	385x170mm	1,6kg	5x

Kit chiavi a bussola da 1/4" 19 pezzi



Composizione:

- (13x) Chiavi a bussola esagonali da 1/4": 4, 4,5, 5, 5,5, 6, 7, 8, 9, 10, 11, 12, 13, 14 mm
- (1x) Giunto universale 1/4" 40mm
- (1x) Barra scorrevole 1/4" 115mm
- (2x) Prolunghe da 1/4" 50, 100mm
- (1x) Cricchetto da 1/4"
- (1x) Impugnatura da 1/4"

REF			
8511	385x170mm	1kg	5x

Kit chiavi a bussola da 1/2" 26 pezzi



Composizione:

- (21x) Chiavi a bussola da 1/2": 8, 10, 11, 12, 13, 14, 15, 16, 17, 18, 19, 20, 21, 22, 23, 24, 26, 27, 28, 30, 32 mm
- (1x) Giunto universale da 1/2"
- (1x) Barra scorrevole da 1/2" 250 mm
- (2x) Prolunghe 125 e 250 mm
- (1x) Cricchetto da 1/2"

REF			
8515	385x170mm	4,4kg	5x

Modulo chiavi 1/2" bi-hex. 21 Pz

Kit chiavi a bussola da 1/2" 26 pezzi



Composizione:

Misures: 8mm, 9mm, 10mm, 11 mm, 12mm, 13mm, 14mm, 15mm, 16mm, 17mm, 18mm, 19mm, 20mm, 21mm, 22mm, 24mm, 27mm, 30mm, 32mm, 34mm, 36mm

REF



2125

375x170x30mm

1,5kg

5x

Composizione:

(14x) Chiavi a bussola esagonali da 1/2": 8, 9, 10, 11, 12, 13, 14, 15, 16, 17, 18, 19, 20, 22 mm
 (6x) Chiavi a bussola esagonali profonde da 1/2": 13, 14, 15, 17, 18, 19 mm
 (2x) Prolunghe da 1/2": 75 mm e 125 mm
 (1x) Giunto snodato da 1/2"

REF



8604

385x170mm

1,3kg

5x

Module 3 pinces



Kit pinze 4 pezzi

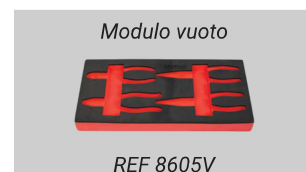

Composizione:

- (1x) Pinza da taglio
- (1x) Pinza lunga
- (1x) Pinza universale

REF			
8605	385x170mm	1,23kg	5x

Module 3 pinces isolées (1000v)

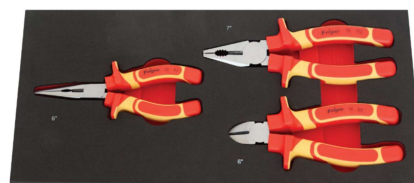

Composizione:

- (2) Pinza con punta curva 200 mm, pinza con punta diritta 200 mm
- (1x) Pinza da taglio 150 mm
- (1x) Pinza universale 180 mm

REF			
8512	385x170mm	1kg	5x

Composizione:

- (1x) Pinza lunga 150 mm
- (1x) Pinza da taglio 150 mm
- (1x) Pinza universale 180 mm

REF			
8600	385x170mm	1,3kg	5x

 Kit pinze extra lunghe 3 pezzi

 **Composizione:**

- (1x) Pinza lunga 280 mm
- (1x) Pinza lunga 90° 250 mm
- (1x) Pinza lunga 45° 280 mm

REF			
8593	385x170mm	1,3kg	5x

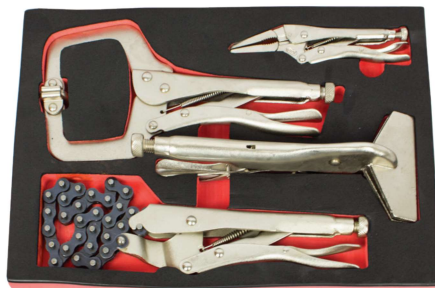
 Kit pinze per carrozzeria 4 pezzi

 **Composizione:**



- (1x) Pinza autobloccante diametro 150 mm
- (1x) Pinza autobloccante a collo d'oca 280 mm
- (1x) Pinza autobloccante 240 mm
- (1x) Pinza autobloccante 160 mm

REF			
8576	385x345mm	2,5kg	5x

 Kit pinze autobloccanti 3 pezzi

 **Composizione:**

- (1x) Pinza autobloccante 250 mm
- (1x) Pinza autobloccante 180 mm
- (1x) Pinza autobloccante 150 mm

REF			
8601	385x170mm	1,1kg	5x

 Kit pinze 2 pezzi

 **Composizione:**

- (1x) Pinza pompa dell'acqua 250 mm
- (1x) Pinza autobloccante 250 mm

REF			
8523	385x170mm	1,1kg	5x

Modulo vuoto



REF 8523V

Kit pinze per anelli di sicurezza 4 pezzi

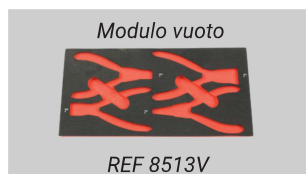

Composizione:

- (2x) Pinze per anelli di sicurezza esterni e curvati 180 mm
- (2x) Pinze per anelli di sicurezza interni e curvati 180 mm

REF			
8513	385x170mm	1kg	5x

Kit chiave a bussola impugnatura a T 8 pezzi

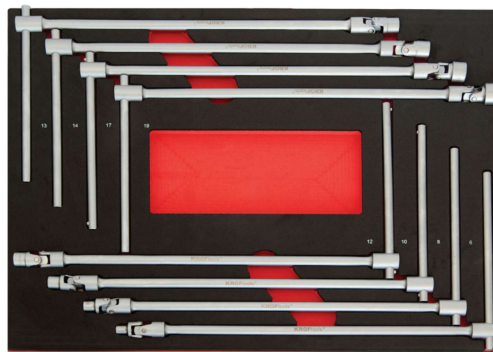

Kit rivettatrice e rivetti 101 pezzi



Composizione:

- (1x) Rivettatrice
- (25x) Rivetti da 2,5 mm di diametro
- (25x) Rivetti da 3 mm di diametro
- (25x) Rivetti da 4 mm di diametro
- (25x) Rivetti da 5 mm di diametro

REF			
8529	385x170mm	1kg	5x

Composizione:

- (8x) Chiave a bussola con impugnatura a T 6x400mm
8x400mm, 10x400mm, 12x400mm, 13x400mm, 14x400mm
17x400 mm, 19x400mm

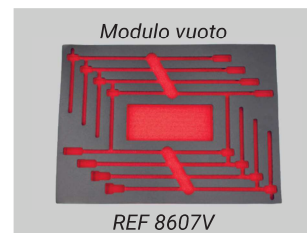

REF			
8607	375x345mm	3,5kg	5x

 Kit chiavi torx t 6 pezzi

 **Composizione:**

(6x) Chiave torx a T T10x100 mm, T15x100 mm, T20x100 mm, T25x150 mm, T27x150 mm, T30x150 mm

REF			
8608	385x170mm	550gr	5x

 Kit chiavi esagonali t 6 pezzi



Modulo vuoto



REF 8514V

 **Composizione:**

(6x) Chiave esagonale: 2x100 mm, 2,5x100 mm, 3x100 mm, 4x150 mm, 5x150 mm, 6x150 mm

REF			
8514	385x170mm	1kg	5x

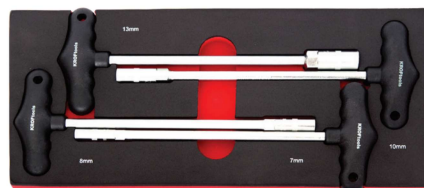
 Impugnatura a T esag. Kit chiave a bussola 4 pezzi

 **Composizione:**

(4x) Chiave a bussola esagonale impugnatura a T: 7 mm, 8 mm, 10 mm, 13 mm

REF			
8588	385x170mm	1,3kg	5x

 Kit cacciaviti a bussola esagonale 6 pezzi

 **Composizione:**

(6) Cacciaviti: 6 mm, 7 mm, 8 mm, 9 mm, 10 mm, 12 mm

REF			
8589	385x170mm	1,3kg	5x

Kit cacciaviti torx T10-T40 7 pezzi

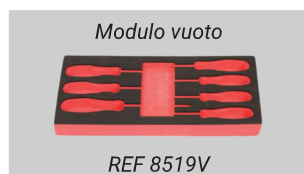

Composizione:

(7x) Cacciaviti torx: T10x75 mm, T15x75 mm, T20x100 mm, T25x100 mm, T27x100 mm, T30x125 mm, T40x150 mm

REF			
8519	385x170mm	850gr	5x

Kit cacciaviti isolati 7 pezzi



Composizione:

(3x) Cacciavite Phillips: PH1x85 mm, PH2x100 mm, PH3x150 mm
(4x) Cacciavite piatto: 3x75 mm, 4x100 mm, 5x125 mm, 6x150 mm
Tensione massima supportata: 1000 V

REF			
8599	385x170mm	1,3kg	5x

Kit cacciaviti piatti e ph 8 pezzi

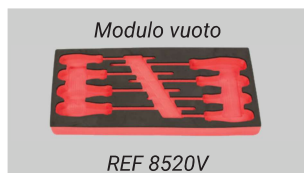

Composizione:

(4x) Cacciavite piatto: 6x38 mm, 4x100 mm, 5x100 mm, 6x150 mm
(4x) Cacciavite Phillips: PH2x38 mm, PH1x100 mm, PH2x100 mm, PH3x150mm

REF			
8520	385x170mm	750gr	5x

Kit cacciaviti isolati 14 pezzi



Composizione:

(4x) Cacciavite piatto: 3x75mm, 4x100mm, 5,5x125mm, 6,5x150mm
(4x) Cacciavite piatto elettronico: 1,8, 2, 2,4, 3mm
(2x) Cacciavite Phillips: PH1, PH2 (100 mm)
(3x) Cacciavite piatto elettronico Phillips: PH0, PH00, PH000
(1x) Kit torx: T9, T10, T15, T20, T25, T27, T30, T40

REF			
8570	385x170mm	1kg	5x

Kit bit 85 pezzi

Modulo vuoto

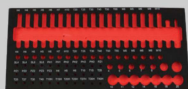

REF 8516V

Composizione

- bits 1/4" (25 mm):

(7x) Torx inviolabile: T10H, T15H, T20H, T25H, T27H, T30H T40H

(7x) Torx: T10, T15, T20, T25, T27, T30, T40

(3x) Esagonale: 4 mm, 5 mm, 6 mm

(6x) Phillips: PH1, PH1, PH2, PH2, PH3, PH3

(6x) Pozidriv: PZ1, PZ1, PZ2, PZ2, PZ3, PZ3

(4x) Piatto: 4mm, 4mm, 6mm, 6mm

- bits 10 mm (30 mm)

(7x) Esagonale: 4mm, 4mm, 5mm, 5mm, 6mm, 7mm, 10mm

(6x) Torx: T20, T25, T30, T40, T50, T55

(5x) XZN: M5, M5, M6, M8, M10

- bits 10 mm (75 mm)

(7x) Esagonale: 4mm, 4mm, 5mm, 5mm, 6mm, 7mm, 10mm

(6x) Torx: T20, T25, T30, T40, T50, T55

(5x) XZN: M5, M5, M6, M8, M10

(5x) Chiave a bussola int. torx da 1/4": E4, E5, E6, E7, E8

(7x) Chiave a bussola int. torx da 1/2": E10, E11, E12, E14, E16, E18, E20

(1x) Adattatore bit da 1/2" x 10 mm

(1x) Adattatore bit da 3/8" x 10 mm

(1x) Adattatore bit magnetico da 1/4"

(1x) Adattatore a innesto rapido da 1/4"

REF



8516

385x170mm

1,96kg

5x

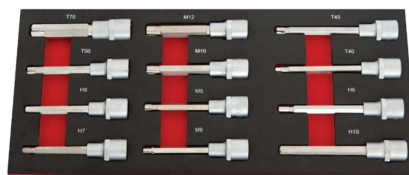
Kit chiave a bussola con bit torx & esagonale da 1/2" 12 pezzi

Composizione:

(4x) Chiave a bussola bit torx da 1/2": T40x120 mm, T45x120 mm
T50x100 mm, T70x100 mm

(4x) Bussola da 1/2" con bit XZN: M6x100 mm, M8x100 mm
M10x100 mm, M12x100 mm

(4x) Chiavi a bussola bit esagonali: 6x120 mm, 7x120 mm
8x120 mm, 10x120 mm

REF



8603

385x170mm

1,3kg

5x

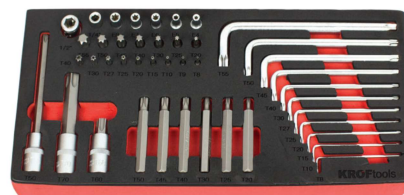
Kit chiavi torx L e torx interior 43 pezzi

Composizione:

(11x) Torx L: T8, T10, T15, T20, T25, T27, T30, T40, T45, T50, T55

(6x) Bit torx: 10x75 mm: T20, T25, T30, T40, T45, T50

(7x) Bit torx profondi 10x30 mm: T20, T25, T30, T40, T45, T50, T55

(9x) Bit torx da 1/4"x25 mm: T8, T9, T10, T15, T20, T25, T27, T30, T40

(1x) Adattatore bit da 1/4"x1/4"

(1x) Adattatore bit da 1/4"x1/4"

(3x) Chiavi a bussola bit torx: T60x25 mm, T70x65 mm, T50x100 mm

(5x) Kit chiavi torx interior: E4, E5, E6, E7, E8

REF



8575

385x170mm

1,45kg

5x

Kit raspe 5 pezzi

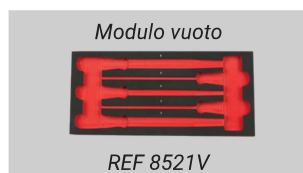

Composizione:

- (1x) Raspa parallela
- (1x) Raspa quadrata
- (1x) Raspa rotonda
- (1x) Raspa triangolare
- (1x) Raspa spessa

REF	📏	⚖️	📦
8521	385x170mm	1,02kg	5x

Modulo utensile martello 6 pezzi



Composizione:

- (1x) Martello da 500 gr
- (1x) Martello di nylon 40 mm
- (4x) Sezioni estrattori: 3x150 mm, 4x150 mm, 5x150 mm, 6x150 mm

REF	📏	⚖️	📦
8592	385x170mm	1,75kg	5x

Kit punzoni 9 pezzi

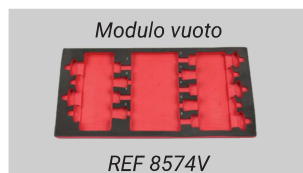
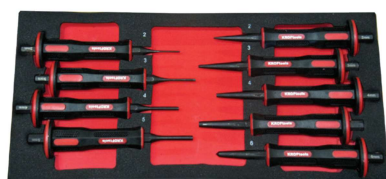

Composizione:

- (1x) Punzone ugello: 6 mm
- (4x) Punzoni conici: 2 mm, 3 mm, 4 mm, 5 mm
- (4) Bulloni estrattori: 2 mm, 3 mm, 4 mm, 5 mm

REF	📏	⚖️	📦
8574	385x170mm	1,55kg	5x

Kit martelli 2 pezzi



Composizione:

- (1x) Martello da 500 gr
- (1x) Martello di nylon 40 mm

REF	📏	⚖️	📦
8522	385x170mm	1,4kg	5x

Kit utensili di misurazione 7 pezzi

12 moduli contenitore di stoccaggio

Modulo vuoto



REF 8528V

Composizione:

- (1x) Righello 300 mm / 12"
- (1x) Forbici
- (1x) Spessimetro 13 spessori 0,05-1,00 mm
- (1x) Metro a nastro 3 m
- (1x) Calibro Vernier 150 mm
- (1x) Coltello a scatto
- (1x) Tracciatore

REF			
8528	385x170mm	1,36kg	5x

Composizione:

- (6x) Stoccaggio 20x45x95 mm
- (6x) Stoccaggio 20x45x70 mm

REF			
8537	385x170mm	100gr	5x

Modulo chiave regolabile, pistola cucitrice, coltello 7 pezzi

Modulo chiave giratubi 11 pezzi



Composizione:

- (1x) Coltello
- (1x) Chiodo
- (2x) Chiavi regolabili 160 mm e 210 mm
- (1x) Scatola da 500x graffe a V
- (1x) Scatola da 500x graffe a U
- (1x) Scatola da 500x graffe a T

REF			
8571	385x170mm	1,2kg	5x

Composizione:

- (11x) Chiavi: 8 mm, 10 mm, 11 mm, 12 mm, 13 mm, 14 mm, 15 mm, 16 mm, 17 mm, 18 mm, 19 mm

REF			
8572	385x170mm	2,5kg	5x

Kit chiavi tubolari 7 pezzi

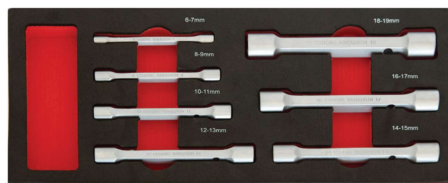

Kit chiavi combinate 6-24mm 6 pezzi



Composizione:

(7x) Chiavi 6-7x104 mm, 8-9x110 mm, 10-11x118 mm 12-13x138 mm, 14-15x145 mm, 16-17x155 mm, 18-19x164 mm

REF			
8598	385x170mm	1,3kg	5x

Composizione:

(6x) Chiavi: 6-8 mm, 10-12 mm, 13-14 mm, 15-17 mm 19-21 mm, 22-24 mm

REF			
8517	385x170mm	1,15kg	5x

Kit chiavi a bussola snodate 6 pezzi



Kit chiavi ad anello doppie 8 pezzi

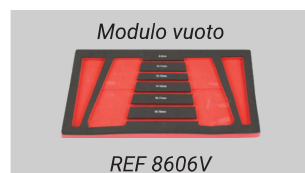

Composizione:

(6x) Bussole: 8-9x200 mm, 10-11x215 mm, 12-13x235 mm 14-15x245 mm, 16-17x260 mm, 18-19x275 mm

REF			
8606	385x170mm	1,5kg	5x

Composizione:

(8x) Chiavi: 6-7 mm, 8-9 mm, 10-11 mm, 12-13 mm 14-15 mm, 16-17 mm, 18-19 mm, 20-22 mm

REF			
8524	385x170mm	1kg	5x

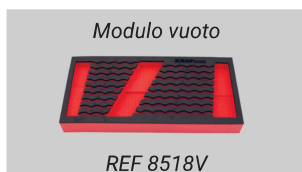
 Kit chiavi combinate 6-22 mm 17 pezzi

 **Composizione:**

(17x) Chiavi 6 mm, 7 mm, 8 mm, 9 mm, 10 mm, 11 mm, 12 mm, 13 mm, 14 mm, 15 mm, 16 mm, 17 mm, 18 mm, 19 mm, 20 mm, 21 mm, 22 mm

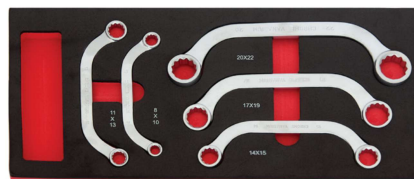
REF			
8518	385x170mm	1kg	5x

 Kit chiavi ad anello doppie a U 5 pezzi

 **Composizione:**

(5x) Chiavi 8-10x125 mm, 11-13x145 mm, 14-15x170 mm, 17-19x190 mm, 20-22x225 mm

REF			
8596	385x170mm	1,3kg	5x

 Kit chiavi a doppio anello 21-32 mm 4 pezzi

 **Composizione:**

(4x) Chiave ad anello 21-23 mm, 24-27 mm, 25-28 mm, 30-32 mm

REF			
8525	385x170mm	1kg	5x

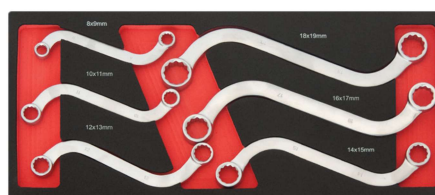
 Kit chiavi a doppio anello a S 6 pezzi

 **Composizione:**

(6x) Chiavi 8-9x125 mm, 10-11x140 mm, 12-13x160 mm, 14-15x190 mm, 16-17x225 mm, 18-19x235 mm

REF			
8594	385x170mm	950gr	5x

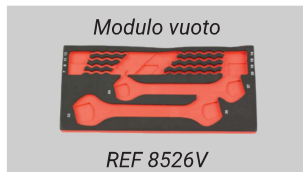
Kit chiave a doppio anello aperto 10 pezzi



Composizione:

(10x) Chiavi 6-7 mm, 8-9 mm, 10-11 mm, 12-13 mm, 14-15 mm, 16-17 mm, 18-19 mm, 20-22 mm, 24-27 mm, 30-32 mm

REF			
8526	385x170mm	1kg	5x

Kit chiavi a cricchetto combinate 12 pezzi



Composizione:

(12x) Chiavi 8x140 mm, 9x150 mm, 10x160 mm, 11x165 mm, 12x170 mm, 13x180 mm, 14x190 mm, 15x200 mm, 16x205 mm, 17x225 mm, 18x240 mm, 19x250 mm

REF			
8591	385x170mm	1,7kg	5x

Kit chiavi combinate 24-32 mm



Composizione:

(5x) Chiavi 24 mm, 27 mm, 29 mm, 30 mm, 32 mm

REF			
8527	375x343mm	1kg	5x

Kit chiavi combinate a cricchetto flessibili 8 pezzi

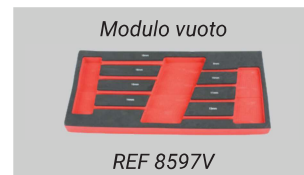
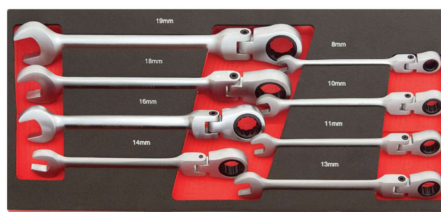

Composizione:

(8x) Chiavi 8x140 mm, 10x160 mm, 11x160 mm, 13x175 mm, 14x190 mm, 16x210 mm, 18x240 mm, 19x250 mm

REF			
8597	385x170mm	1,3kg	5x

 Modulo chiave combinata a cricchetto e bit da 1/4"



 **Composizione:**

(13x) Chiave combinata a cricchetto: 8, 9, 10, 11, 12, 13, 14, 15, 16, 17, 19, 21, 22 mm
 (9x) Chiavi Umbrako L: 1,5, 2, 2,5, 3, 4, 5, 6, 8, 10 mm
 (23x) Chiavi a bussola con bit torx: T8, T10, T15, T20, T25, T30, T40
 (1x) Bit esagonale: 3, 4, 5, 6, 7, 8 mm
 (1x) Bit Phillips: PH1, PH2, PH3

(1x) Bit Pozidriv: Pz1, Pz2, Pz3
 (1x) Bit a taglio: SI3, SI4, SI5, SI6

REF

8569



545x425mm



4kg



2x

Kit utensili con 236 pezzi per 6 cassette

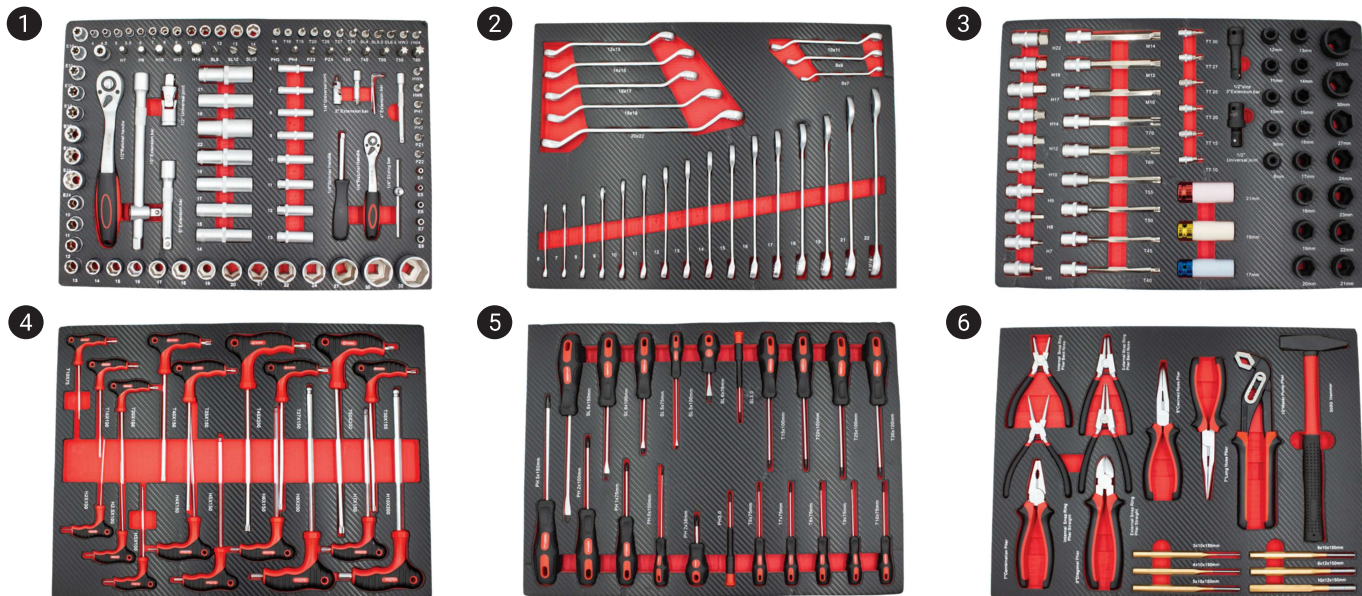

Composizione:

MODULO 1

- 2x Cricchetti
- 4x Inserti 1/4"
- 2x Cardani
- 1x Adattatore da 3/8" femmina a 1/2" maschio (CRV)
- 1x Slitta 1/4" (CRV)
- 1x Adattatore 1/4" (acciaio al carbonio)
- 3x Chiavi esagonale
- 13x Chiavi a bussola da 1/4"
- 17x Chiavi a bussola da 1/2"
- 8x Chiavi a bussola lunghe da 1/4"
- 7x Chiavi a bussola lunghe da 1/2"
- 1x Adattatore 1/2
- 5x Chiavi a bussola Torx interne da 1/4"
- 8x Chiavi a bussola Torx interne da 1/2"
- 17x Punta
- 18x Chiavi a bussola con punta T30, T27, T25, T20,

MODULO 2

- 16x Chiavi combinate (acciaio al carbonio)
- 8x Chiavi combinate a cricchetto

MODULO 3

- 20x Chiavi a bussola per avvitatore a percussione
- 1x Giunto cardanico universale a impatto 1/2" (CRV)
- 1x Inserti percussione da 1/2" 75 mm (CRV)
- 3x Avvitatori a percussione da 1/2" (con rivestimento): 17,19,21 mm (CRV)
- 6x Punta da 1/4"

- 10x Chiavi a bussola 1/2" con punta H6, H7, H8, H9, H10, H12, H14, H17, H19, H22, lunghezza: 55 mm
- 9x Chiavi a bussola da 1/2" con punta lunga: T40-T45-T50-T55-T60-T70-M10-M12-M14, Lunghezza: 139 mm

MODULO 4

- (18x) Chiavi a T

MODULO 5

- 19x Chiavi con impugnatura
- 2x Chiavi con impugnatura

MODULO 6

- 1x Pinze per pompe dell'acqua 250 mm (acciaio al carbonio)
- 1x Martello meccanico 300 g (acciaio al carbonio)
- 1x Pinze universali da 175 mm (acciaio al carbonio)
- 1x Pinze a becchi lunghi curvi da 200 mm (acciaio al carbonio)
- 1x Pinze a becchi da 200 mm (acciaio al carbonio)
- 1x Pinze taglio da 175 mm (acciaio al carbonio)
- 4x Pinze freni chiusura curva / pinze freni apertura curva Pinze freni apertura diritta / pinze freni con chiusura diritta 150 mm (acciaio al carbonio)
- 6x Punzoni cilindrici

86236

21kg

1x

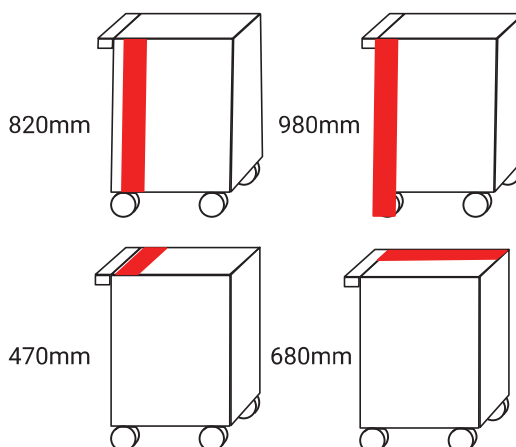
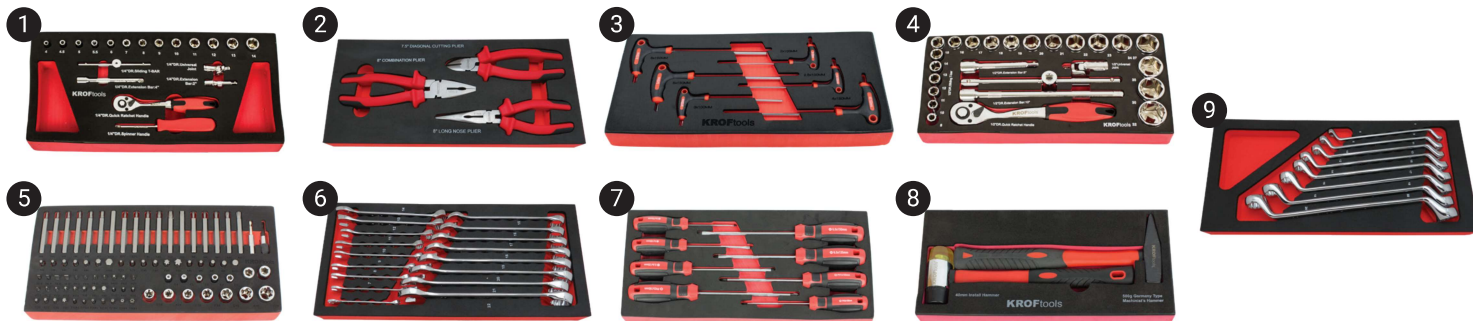
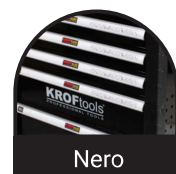
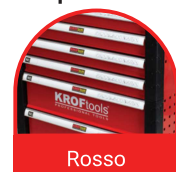
 Armadio portautensili con 7 cassetti 174 pezzi

 Possibilità di
 colore a
 disposizione:

Modulo	Refiremen o	Quantità	Descrizione
1	8511	19x	Chiave a bussola da 1/4"
2	8512	3x	3 pinze
3	8514	6x	Chiavi Umbrako a T
4	8515	26x	Chiavi a cricchetto da 1/2"
5	8516	85x	Bit
6	8518	17x	Chiavi da 6~22 mm
7	8520	8x	Cacciaviti piatti e ph
8	8522	2x	Martelli
9	8524	8x	Chiavi a doppio anello 6-22 mm

Dimensioni carrello:

Altezza (con ruote): 980 mm, altezza: 820 mm

Larghezza: 470 mm, lunghezza: 680 mm

Dimensioni cassetti:

(5x) 60x400x530mm

(2x) 140x400x530mm

REF

8501



63,51kg



1x

Armadio portautensili con 7 cassettei 237 pezzi

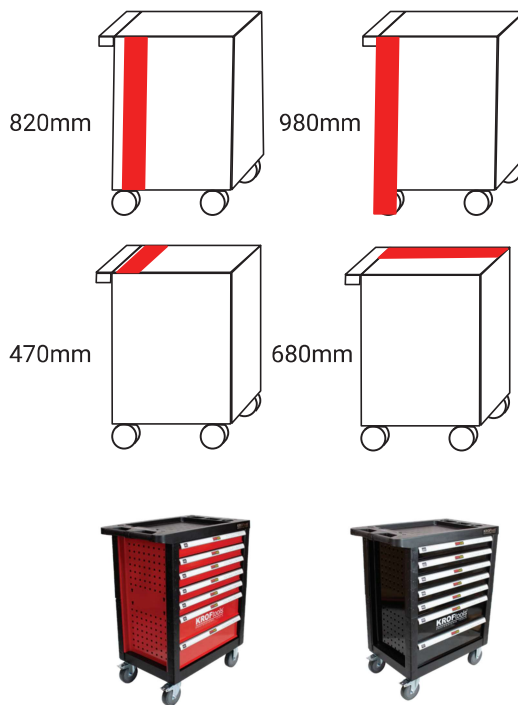

Possibilità di colore a disposizione:



Rosso



Nero



Modulo	Refiremen o	Quantità	Descrizione
1	8510	42x	Chiave a bussola da 1/4"
2	8511	19x	Chiave da 1/4"
3	8512	3x	Pinze
4	8513	4x	Pinza per anelli di sicurezza
5	8515	26x	Chiavi e cricchetto da 1/2"
6	8516	85x	Bit
7	8517	6x	Chiavi combinate 6~24 mm
8	8518	17x	Chiave combinata 6~22 mm
9	8520	8x	Cacciavite
10	8522	2x	Martelli
11	8523	2x	Pinze
12	8524	8x	Chiave ad anello 6~22 mm
13	8526	10x	Chiave ad anello doppio aperto 6~32 mm
14	8527	5x	Combinazione 24~42 mm



Dimensioni carrello:

Altezza (con ruote): 980 mm, altezza: 820 mm

Larghezza: 470 mm, lunghezza: 680 mm

Dimensioni cassettei:

(5x) 60x400x530mm

(2x) 140x400x530mm

REF

8500



68,90kg

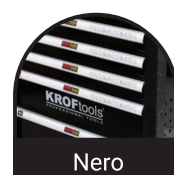
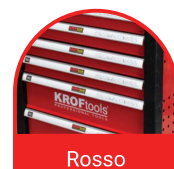

1x

 Armadio portautensili 7 cassetti 259 pezzi

Modulo	Riferimento	Quantità	Descrizione:
1	8510	42x	Chiave a bussola da 1/4"
2	8511	19x	Chiave a bussola da 1/4"
3	8512	3x	Pinze
4	8513	4x	Pinze per anelli di sicurezza
5	8514	6x	Chiave Umbrako a T
6	8515	26x	Bussole e cricchetto da 1/4"
7	8516	85x	Bit
8	8517	6x	Chiavi combinate 6-24 mm
9	8518	17x	Chiavi a gancio 6-22 mm
10	8519	7x	Cacciaviti torx T10-T40
11	8520	8x	Cacciaviti
12	8521	6x	Raspa
13	8522	2x	Martelli
14	8523	2x	Pinze
15	8524	8x	Chiave ad anello 6~22 mm
16	8525	4x	Chiave ad anello 21~32 mm
17	8526	10x	Chiave 6~32 mm
18	8527	5x	Chiave combinata 24~32 mm
19	8574	9x	Punzoni e perni



Dimensioni carrello:

Altezza (con ruote): 980 mm, altezza: 820 mm
Larghezza: 470 mm, lunghezza: 680 mm

Dimensioni cassetti:

(5x) 60x400x530mm
(2x) 140x400x530mm

8502

74,32kg

1x

 Armadio portautensili 7 cassetti 547 pezzi

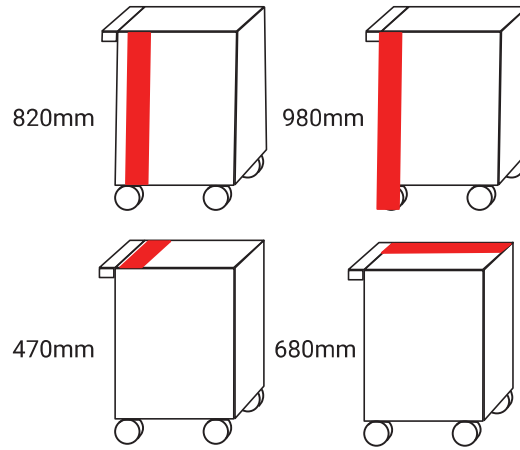

Modulo	Riferimento	Quantità	Descrizione:
1	8510	42x	Chiave a bussola da 1/4"
2	8511	19x	Chiave a bussola da 1/4"
3	8512	3x	Pinze
4	8513	4x	Pinze per freni
5	8515	26x	Chavi a bussola 1/2" e cricchetto
6	8516	85x	Punte
7	8517	6x	Chiavi del freno 5-24mm
8	8518	17x	Chiave com. a cricchetto 6~22 mm
9	8520	8x	Chiavi a croce

Modulo	Riferimento	Quantità	Descrizione:
10	8522	2x	Martelli
11	8523	2x	Pinze
12	8524	8x	Chiave comb. cricchetto 6~22 mm
13	8526	10x	Chiavi a bocca aperta 6-32mm
14	8527	5x	Chiave comb cricchetto 24~32 mm
15	8528	7x	Strumento di misura
16	8529	101x	Rivettatrice e rivetti
17	8571	7x	Chiave inglese, graffettatrice e tag.
18	8537	1X	12 Vani portaoggetti



Dimensioni carrello:

Altezza (con ruote): 980 mm, altezza: 820 mm

Larghezza: 470 mm, lunghezza: 680 mm

Dimensioni cassetti:

(5x) 60x400x530mm

(2x) 140x400x530mm

REF			
8353VER	red / rouge	72,4kg	1x
8353PRE	black / noir	72,4kg	1x

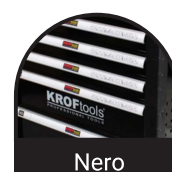
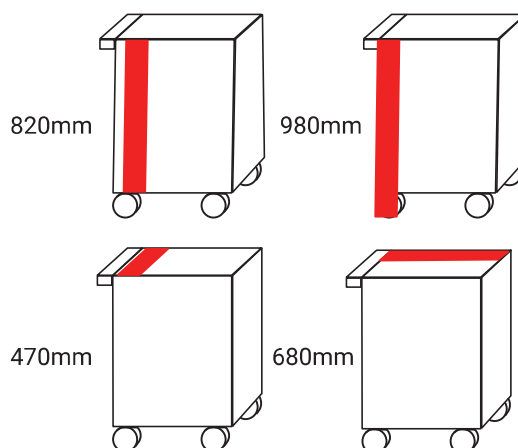
 Armadio portautensili 7 cassetti 160 pezzi

Modulo	Quantità	Descrizione
1	68x	Chiavi a bussola e cricchetti da 1/4", 3/8", 1/2"
2	35x	Chiave comb., chiave doppia aperta, chiave ad anello
3	34x	Cacciaviti e avvitatori elettrici
4	9x	Pinze
5	14x	Martello e chiavi es. e torx

**Dimensioni carrello:**

Altezza (con ruote): 980 mm, altezza: 820 mm

Larghezza: 470 mm, lunghezza: 680 mm

Dimensioni cassetti:

(5x) 60x400x530mm

(2x) 140x400x530mm

REF

8612



65kg

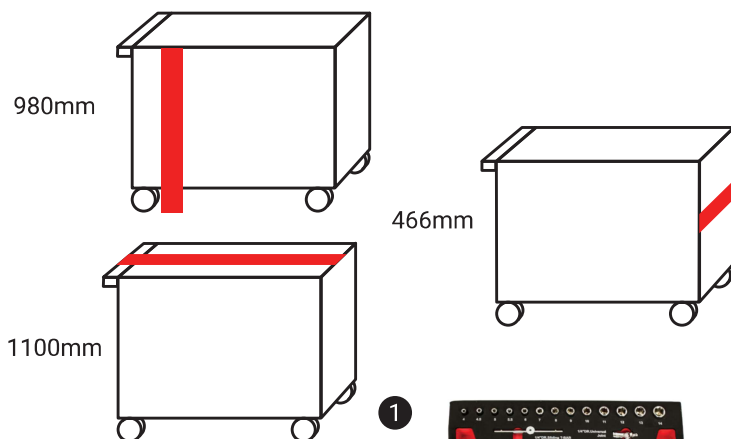

1x

 Armadio portautensili 14 cassetti 596 pezzi

Modulo	Riferimento	Quantità	Descrizione:
1	8511	19x	Pezzi chiavi cassetta 1/4"
2	8512	3x	3 pinze
3	8513	4x	Pinze per freni
4	8514	6x	Chiavi a T umbrako
5	8515	26x	Chiavi a bussola 1/2 a cricchetto
6	8516	85x	Punte
7	8517	6x	Chiavi freno 6~24 mm
8	8518	17x	Chiave comb. cricchetto 6~22 mm
9	8519	8x	Torx con impugnatura T10~T40
10	8520	8x	Cacciaviti a taglio e croce
11	8522	2x	Martelli
12	8523	2x	Pinze
13	8524	8x	Chiave comb. cricchetto 6~22 mm
14	8525	4x	Chiave comb. cricchetto 21-32mm

Modulo	Riferimento	Quantità	Descrizione:
15	8526	10x	Chiavi a bocca aperta 6~32 mm
16	8528	7x	Strumento di misura
17	8529	101x	Rivettatrice e rivetti
18	8537	-	Vani portaoggetti
19	8571	7x	Chiave inglese, graffett. e taglierino
20	8572	11x	Chiave a pipa
21	8573	20x	Chiavi a bussola 3/8" 8~24 mm

**Dimensioni carrello:**

Altezza: 980 mm, larghezza: 466 mm
 Lunghezza: 1100 mm (con impugnatura)

Dimensioni cassetti:

(5x) 60x400x530 mm, (5x) 60x270x530 mm,
 (1x) 130x400x530 mm, (1x) 130x270x530 mm,
 (1x) 200x400x530 mm, (1x) 200x270x530 mm

REF

8354



116kg



1x

 Espositore luminoso 2 m

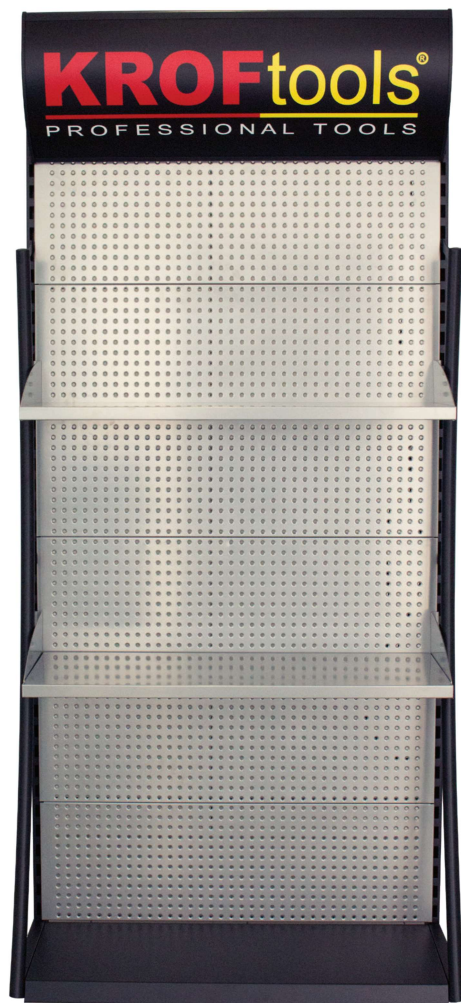

 Espositore per cacciaviti 460x215 mm

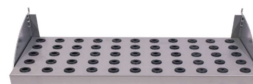



 **Dimensioni:** Larghezza: 215 mm, lunghezza: 460 mm

REF		
DISP5	2kg	1x

 Espositore per bussole 967x250 mm





 **Dimensioni:** Larghezza: 250 mm, lunghezza: 967 mm

REF		
DISP6	3kg	1x

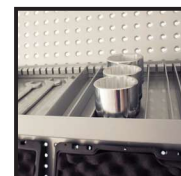
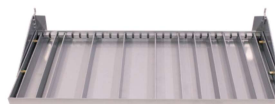
 Espositore per bussole 450x250 mm





 **Dimensioni:** Larghezza: 250 mm, lunghezza: 450 mm

REF		
DISP7	3kg	1x

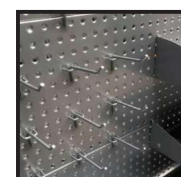
 Gancio 100 mm





 **Dimensioni:** Lunghezza: 100 mm

REF		
DISP3	46gr	1x



 **Dimensioni generali:** 1000x2200x450 mm
Composizione:
(2x) Scaffali 965x350 mm
(50x) Ganci 100 mm

REF		
8595	8kg	1x

 9 Scaffali per chiavi pneumatiche 933x280 mm

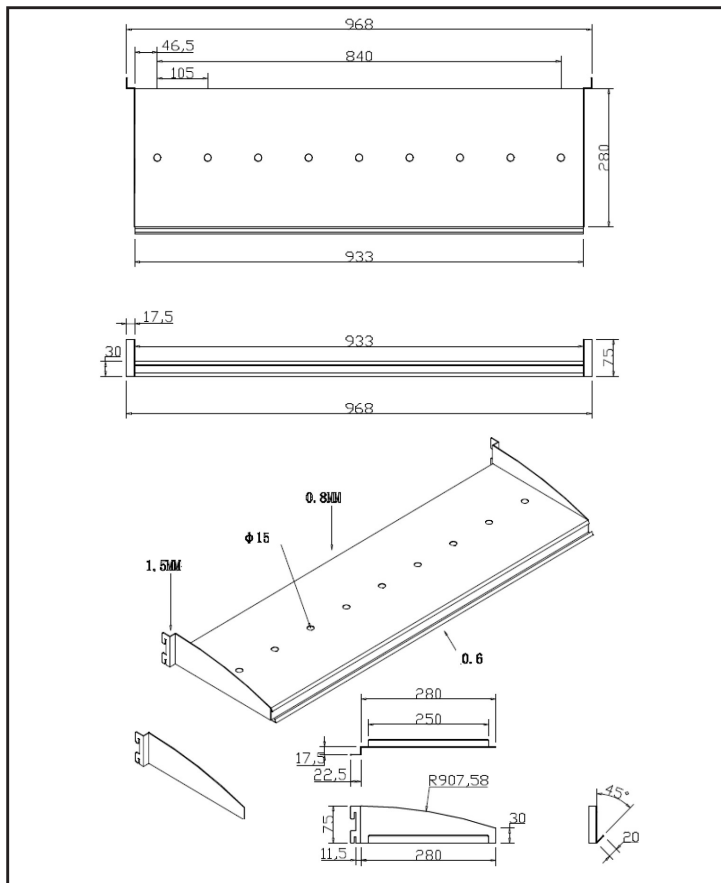



REF		
DISP12	3kg	2x

 3 Espositori chiavi pneumatiche 300x140x340 mm

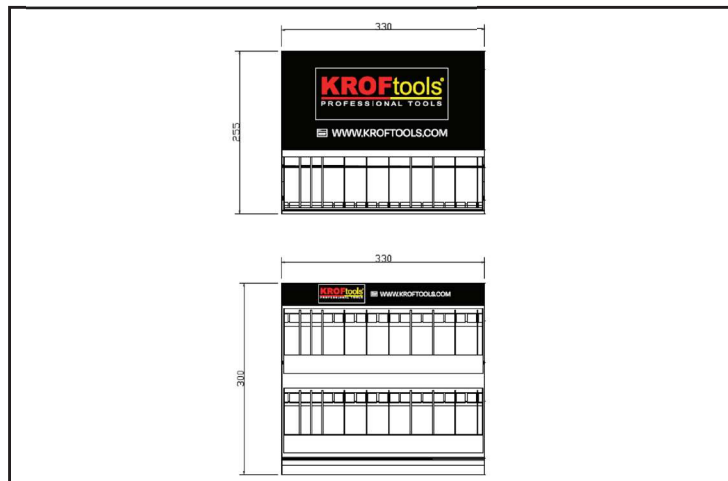
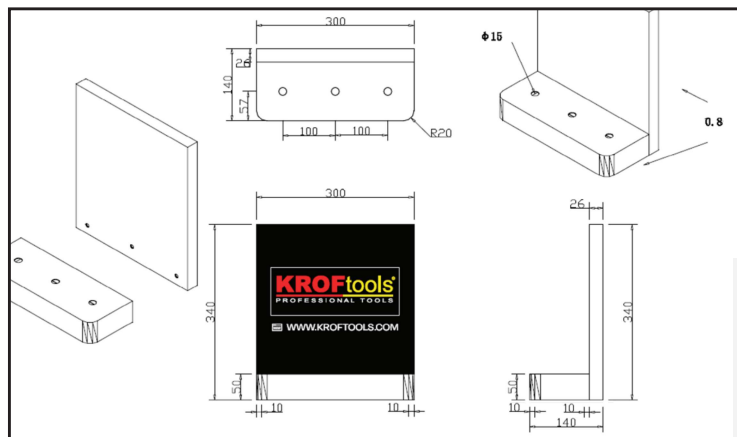
 Espositore chiavi 330x225x300 mm



REF		
DISP13	2kg	1x

REF		
DISP9	6,5kg	1x

54 Espositori cacciaviti 350x310 mm

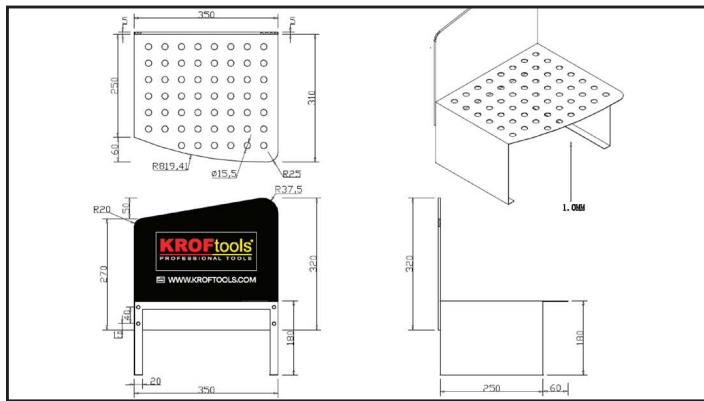

REF		
DISP8	2,5kg	1x

Gancio pneumatico 104 mm

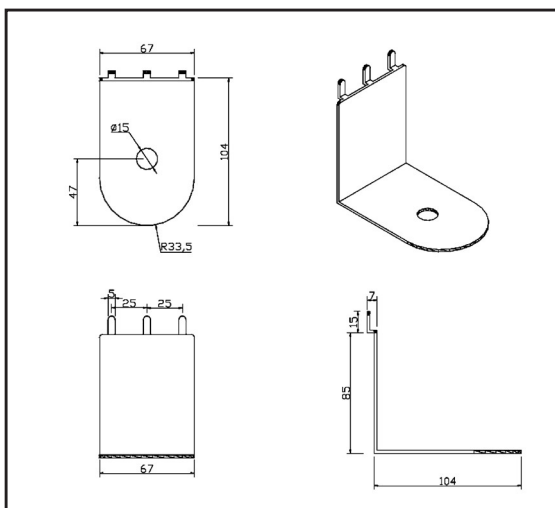

REF		
DISP11	20gr	1x

Espositore mobile triangolare 456x1800 mm

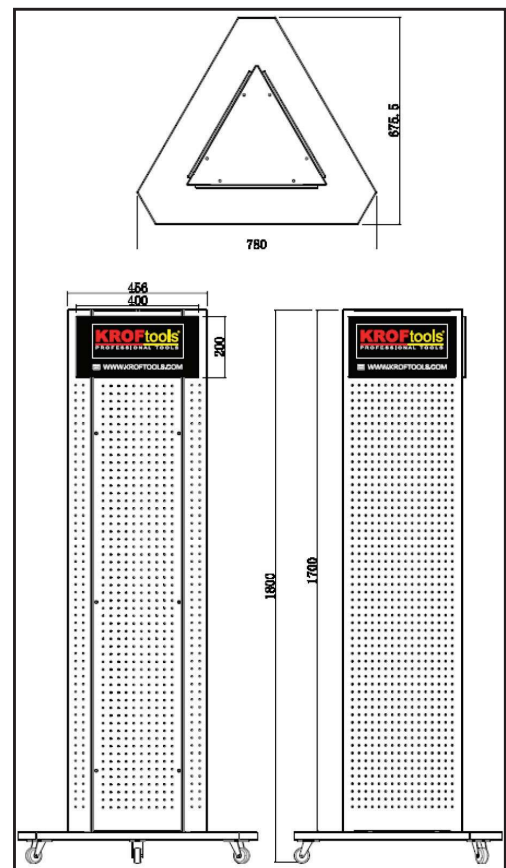
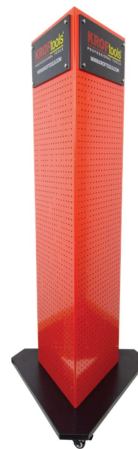
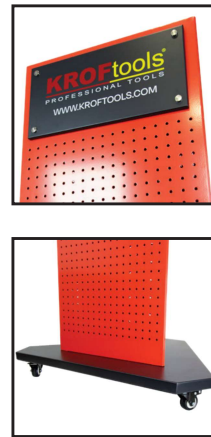

REF		
DISP10	6,9kg	1x

 Armadio con tendine 1,5 m



180mm

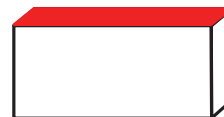

1500mm

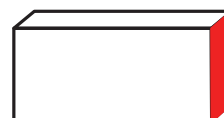

600mm



Gancio



REF 8577 40mm

REF 8578 75mm

Doppio gancio



REF 8579 40mm

 **Misure:**

Altezza 600 mm,
 larghezza 180 mm,
 lunghezza 1500 mm

REF



8507

29kg

1x

 Banco da lavoro 1,5 m

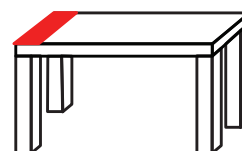

780mm

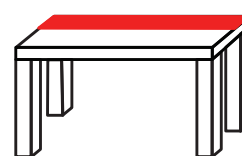

1500mm

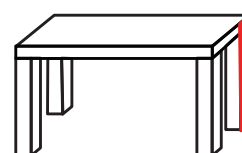

830mm

 **Misure:**

Dimensioni del banco:
 Altezza: 830 mm,
 larghezza: 780 mm,
 lunghezza: 1500 mm

Poids supporté : 200 kg

REF



8506

56kg

2x

 Armadio portautensili vuoto 4 cassetti



500mm

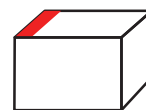

700mm

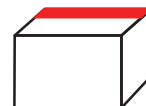

460mm

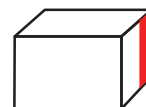

 Misure:

Dimensioni armadio:
Altezza: 60 mm, lunghezza: 535 mm, larghezza: 500 mm
Dimensioni cassetti: (4x) 60x400x535 mm

REF		
8504	29kg	1x

 Banco da lavoro con armadio 1,5 m



780mm

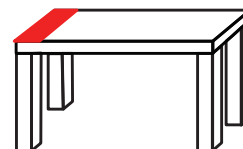

500mm

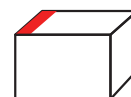

1500mm

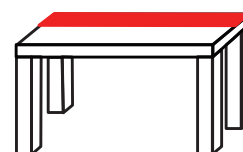

700mm

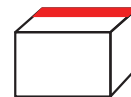

830mm

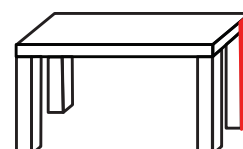



460mm



 Misure:

Banco: Altezza: 830 mm, larghezza: 780 mm, lunghezza: 700 mm
Peso supportato: 200 kg
Armadio: Altezza: 460 mm, larghezza: 500 mm, lunghezza: 700 mm

REF		
8503	91kg	1x

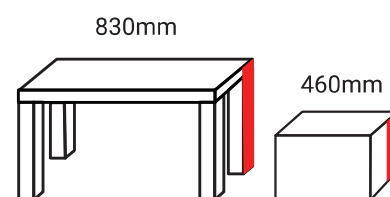
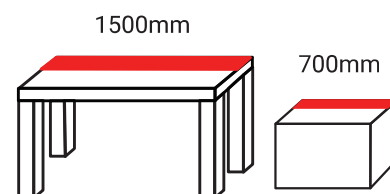
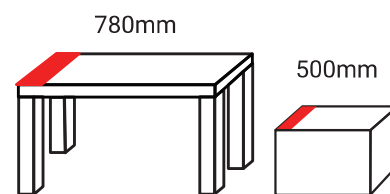
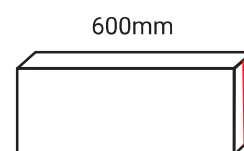
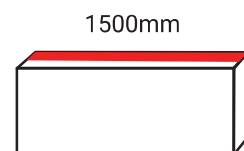
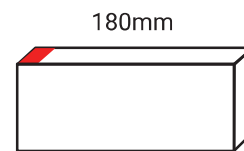
 Postazione da lavoro 1,5 m

 **Dimensioni:**

- Armadio con/tende altezza 600 mm, lunghezza 1500 mm, larghezza 180 mm
- Banco da lavoro altezza 830 mm, lunghezza 1500 mm, larghezza 780 mm
- Peso supportato: 200 kg
- Armadio portautensili: Altezza 460 mm, lunghezza 700 mm, larghezza 500 mm,

REF

8509



122kg



4x

 Banco da lavoro con armadio 1,5 m

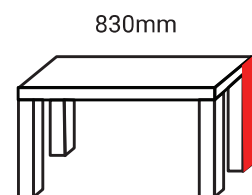
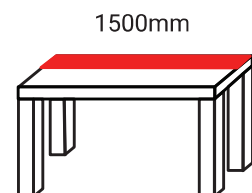
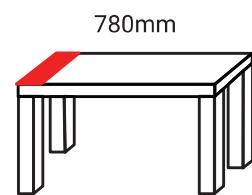
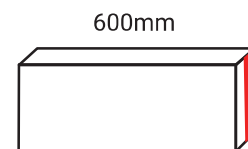
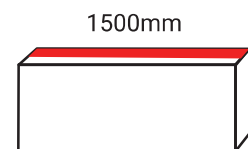
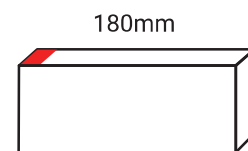

 **Misure:**

Armadio con tende
Altezza 600 mm, lunghezza 1500 mm, larghezza 180 mm
Banco da lavoro
altezza 830 mm, lunghezza 1500 mm, larghezza 780 mm
Peso supportato: 200 kg

REF

8508



88kg

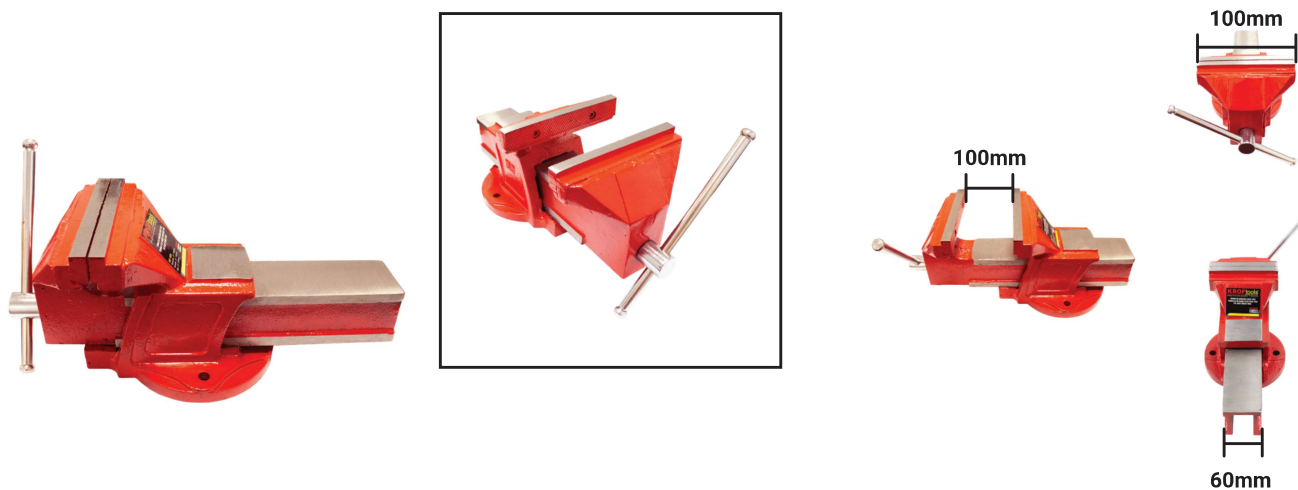

1x

 Morsa da banco a base fissa 100 mm

REF	↔	📏	📄
8004	100mm (4")	6,3kg	2x

 Morsa da banco a base fissa 155 mm

REF	↔	📏	📄
8006	155mm (6")	11,3kg	1x

 Morsa da banco a base fissa 210 mm

REF	↔	📏	📄
8008	210mm (8")	14,6kg	1x

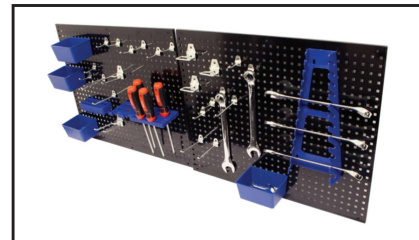
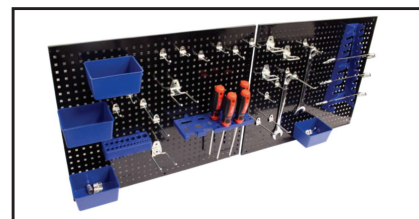
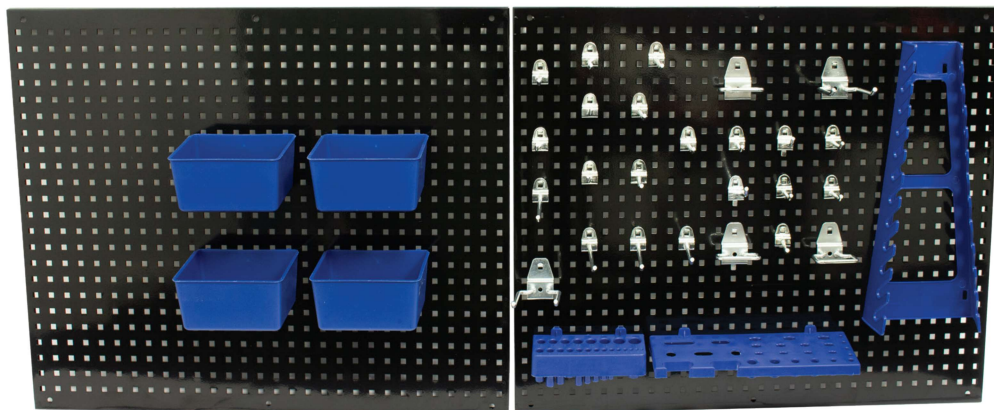

 2 Pannelli forati metallici con 32 accessori

 **Misure**

550x455 mm
 Spessore: 0,5 mm

Composizione:

(15x) Ganci corti semplici
 (5x) Ganci lunghi semplici
 (2x) Doppi ganci
 (3x) Ganci ad ansa

(4x) Custodie di plastica
 (1x) Porta chiavi
 (1x) Porta chiavi con risvolti
 (1x) Fori di supporto

REF



8685

2,9kg

1x

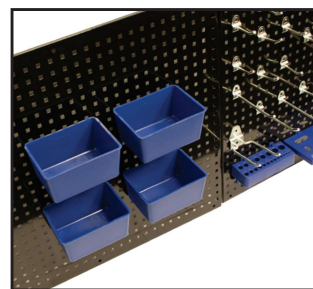
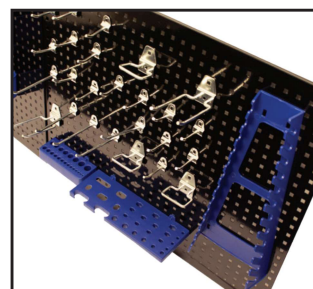
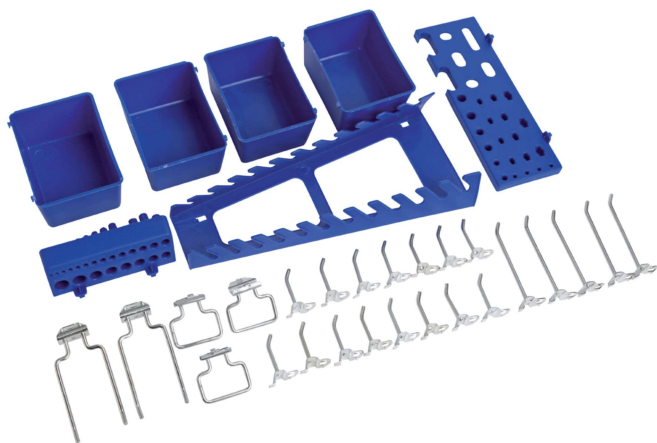
 32 Accessori per il pannello forato metallico

 **Composizione:**

(15x) Ganci corti semplici
 (5x) Ganci lunghi semplici
 (2x) Doppi ganci
 (3x) Ganci ad ansa

(4x) Custodie di plastica
 (1x) Porta chiavi
 (1x) Porta chiavi con risvolti
 (1x) Fori di supporto

REF



8686

1,9kg

20X